

Infrastructure & Industrial Solutions

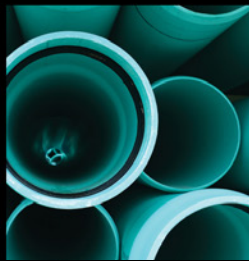

FOR CLEAN WATER, INDUSTRY & ENVIRONMENT

Infrastructure Solutions

Don't go underground without the right connections. Our critical infrastructure, potable water, sanitary and storm water systems are buried underground and largely forgotten.

It is essential that the very best products are used in these systems to ensure safety & longevity. This is our mantra at Pro-Line and we are continuously setting the bar with quality fabricated fittings and distribution of the industry's best products.

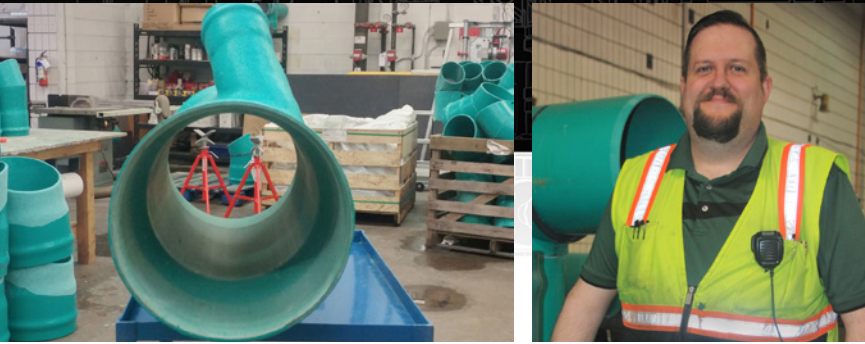

- The pioneers of sewer fitting fabrication who lead the industry with consistent product quality, reliability, and dedication to research & development
- World class fabrication and warehousing facilities in Surrey BC and Barrie ON, delivering exceptional customer service with a knowledgeable team, extensive inventory and custom fabrication
- Gasketed sewer, profile, and tel/hydro/cable duct fittings, inspection chambers, backwater valves & flow controls
- Heavy gauge stainless service tube inserts and service box rods; precision machined service box accessories, valve & curb keys; quality bolt & flange packs

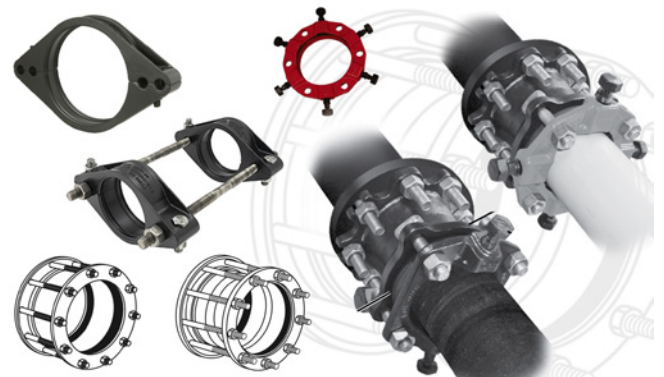

- High quality, fast and economical PVC pressure pipe and sewer pipe bell end and plain end restrainers
- UL listed Uni-flange® plain end pipe flange adapters with free rotating flange, 3° of pipe deflection and torque limited set screw restraint system, make Uni-Flange® the industry leading flange adapter
- Engineered transition couplings, repair couplings, dismantling joints, expansion joints, flange adapters and tapping sleeves available in ductile iron and steel up to 60" in diameter

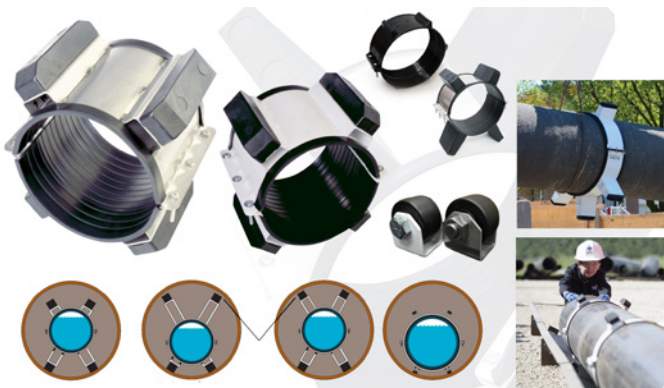

- Robust casing spacers for any pipe casing application in three materials: polyethylene, powder coated carbon steel and stainless steel. Patent pending ApogeeAero® casing spacer features an anti-corkscrew roller system with a static load up to 12,500 lbs and 70% reduction in friction during installation
- Innerlynx® mechanical seals provide exceptional sealing characteristics for annular spaces between a carrier pipe and the ID of a wall penetration. Additional sizes and intuitive pressure plate design make Innerlynx™ the mechanical seals preferred by contractors



- Anti-corrosion petrolatum-based tape, primer and mastic for long-term protection of metal surfaces underground, underwater or exposed in severe environments
- PetroWrap® Anti-Corrosion System CSA Z245.30 compliant
- Meets ANSI/AWWA C217-09 Standard



- Inserta Tee® can connect to the largest range of sizes in the industry and all drainage materials manufactured today. The connections range from 2" through 30" service laterals
- Inserta Tee®'s high performance connections are watertight, air testable and highly durable
- Installation is easy and affordable. Installs without disturbing bedding and there is no need for glues, epoxies, grout or awkward gaskets



- AASHTO M-306, H-25 (50,000 lbs) load rated composite manhole & meter pit frames and covers, 1/3rd the weight of a conventional lid with infiltration proof options, corrosion resistant, radio signal SCOT (SMART friendly), vandal resistant, designed for new construction and retrofit applications
- Heavy duty waterworks industry specific tools. Designed in collaboration with end users to ensure optimal functionality and complete with industry leading warranty

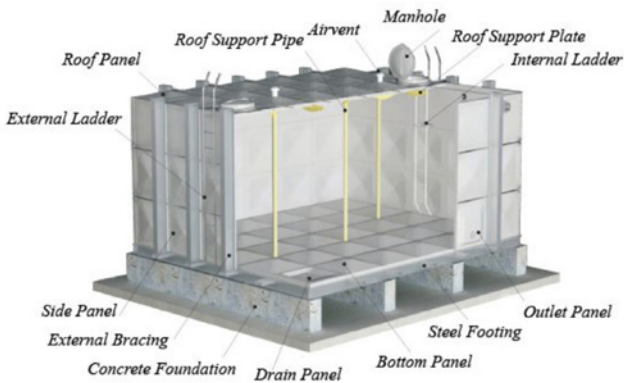

- CSA B126, AWWA D121, & NSF 61 & 372 modular panel FRP tanks, available from 260 gallons to 2.5 million gallons for all temperature and weather extremes, indoor and outdoor use
- Hot press moulded mirror finish prevents bacterial growth
- 100% complete draining, 100+ year life expectancy and 5 year warranty
- High wind and load resistance, 8x dynamic load factor, 3A seismic rated

- Multi/Joint wide range restrained couplings & flange adapters from 2"-24" with industry leading 16° of misalignment possible
- Connects all types of piping material including asbestos cement, PVC, HDPE, ductile & cast iron and stainless steel
- NSF approved municipal coupling of choice for tie-ins and repairs especially with HDPE, SS, & AC pipe

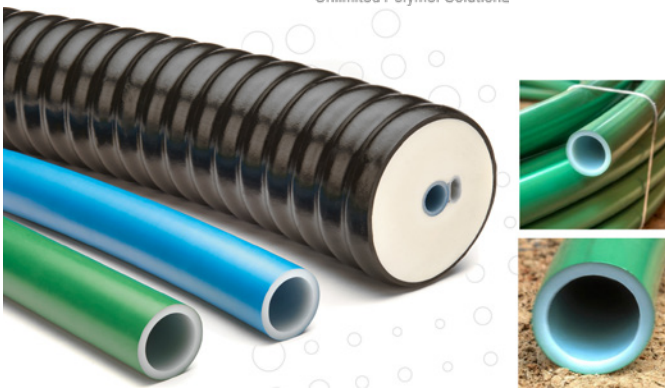

- MUNICIPEX crosslinked polyethylene (PEX-a) municipal service tubing, exceeds CSA B137.5 and certified to NSF 14/61 standards
- Produced in SDR9 copper tube sizes (CTS) and compatible with AWWA C800 valves and fittings, complete with a 25 year warranty

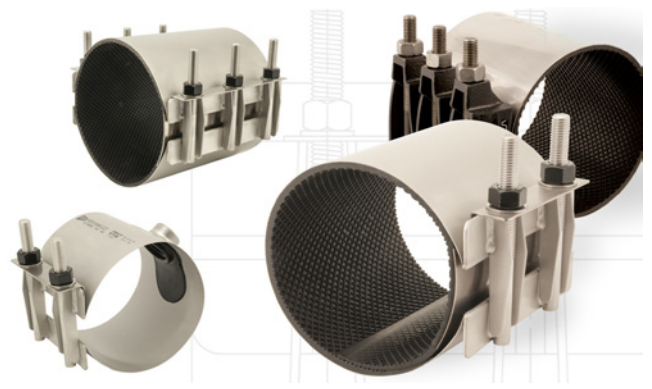

- Heavy gauge passivated 304 stainless steel service saddles & repair clamps, with mould bonded gaskets, consistent machine welded outlets and anti-galling coated hardware

Industrial Solutions

Pro-Line is an innovation forward company with customer focus at its core.

We combine application based problem solving with a specialized array of products to keep our planet healthy.

From municipal water and wastewater treatment to pulp & paper, Pro-Line has the people, products and know-how to deliver optimal plant performance.



PRO-FLARE™ Chemical Piping Systems



- Fluoropolymer chemical tubing system that eliminates leaks common in solvent welded and threaded PVC piping
- Fast and easy to install. Flare connections in less than 30 seconds rated to 100 PSI+
- Safe, reliable, & hassle-free life expectancy with sodium hypochlorite and many other chemical systems
- Expensive tooling not required
- Compatible with all leading PVC valve manufacturers
- Tubing available in continuous coils of over 1000'

SZUSTERsystem innovation is essential



- Patented space saving 90° ball check valves & COMBI isolating check valves, fully open at 0.7 m/s to extend pump system longevity, delivering exceptional solids handling performance & overall system cost savings
- Available from 1-1/4" NPT to 12" ANSI flanged ends, 230 PSI rated ductile iron body with fusion bonded epoxy coating, nitrile coated ball & maintenance friendly corner bonnet design

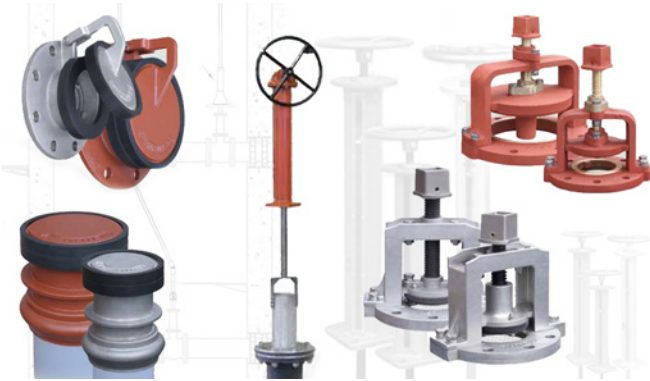

- DI & SS mud valves, hydrostatic pressure relief valves, telescoping valves, chain wheel operators, floor stands, & custom valve adaptation
- NSF/ANSI 61 & 372
- Broad size ranges & flow capacities
- Corrosion resistant robust construction
- Industry-leading wear thresholds
- Eliminate confined space entry
- Intuitive designs & in-house application engineering



- GF Piping Systems is the global expert for maintenance-free and long-lived piping systems made of plastics
- PVC, CPVC, PP, PVDF, ECTFE plastic pipe, valves, fittings, & double containment
- Ball, check, butterfly, needle, diaphragm, gate, pressure sustaining valves in manual, electric & pneumatic actuation types
- Signet water quality and flow instrumentation



- High-temperature and high-pressure industrial sealants and greases that are oxygen-safe, waterproof & non-toxic
- Not affected by harsh chemicals such as chlorine, sodium hypochlorite or other powerful oxidizers
- The worlds best lubricants and solvent-free rust inhibitors

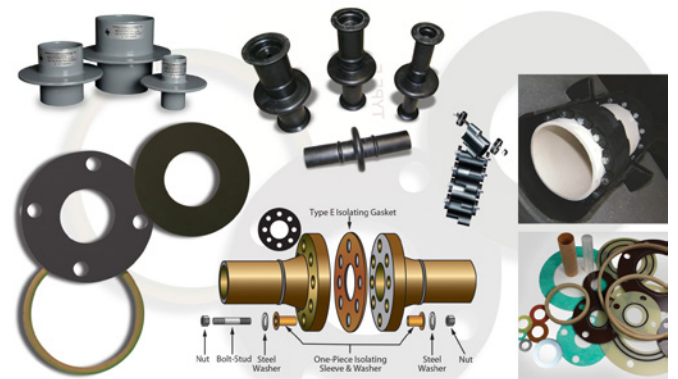

- The industry's best mechanical seals with multiple size ranges and configurations including hydrocarbon resistant & UL approved fire rated
- Used for a wide range of applications, Flange Isolating Gasket Kits effectively seal flange connections and prevent corrosion by eliminating all metal-to-metal contact
- Flange band protectors, bolt & nut protective caps, monolithic isolating joints, safety spray shields, U-bolt protectors & pipe rack guards all designed for safety and corrosion protection

STENNER PUMPS

seko



- Self-priming peristaltic metering pumps
- Quick release pump head for ease of maintenance
- No problems with off-gassing solutions such as sodium hypochlorite
- Anti-siphoning three point roller design
- Multiple input/output signal configurations
- Solenoid driven & motor driven pumps
- Powerful microprocessor technology guarantees dosing accuracy
- Variety of voltages, input & output signal configurations for multiple applications
- Premium PTFE & PVDF materials ensure corrosion resistance and food grade compatibility

agru

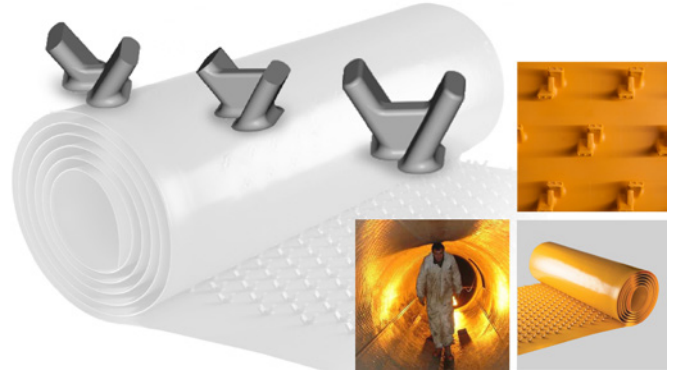

- AGRU high quality concrete protective liners (CPL) offer protection against aggressive and abrasive media as well as groundwater intrusion
- Firmly sealed surfaces keep reinforced concrete in like-new condition for years
- Unique V-shaped embedment anchors provide secure mechanical anchoring of the concrete protective liner to the concrete
- Available in a wide range of materials including PP, PE, PE-el, PVDF and ECTFE. AGRU CPL products are suitable across a wide temperature and chemical range
- Easy installation and outstanding product quality leads to time and cost savings

BLACOH™
FLUID CONTROL



- The industry standard for dampening pulsations created by positive displacement pumps
- Protect piping systems and instruments from pulsation, vibration, water hammer and surge protection.
- Allows for steady continuous flow ensuring accuracy, longevity and repeatability of meters
- Calibration columns, gauge guards, injection quills in a variety of sizes and construction materials

STANDON
PIPE SUPPORTS

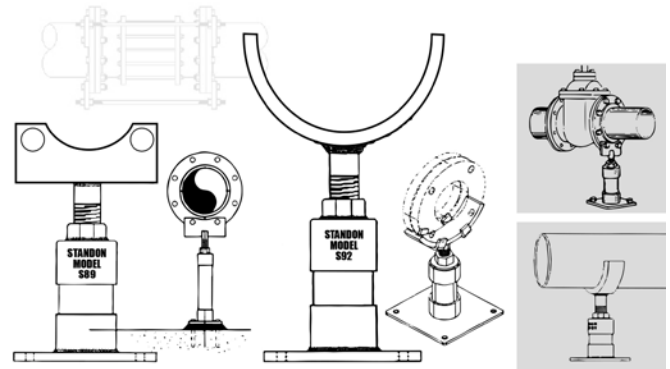

- The original patented pipe support system for pipes up to 48"
- Tested to 10,000 lbs of comprehensive strength
- Laser cut steel for a guaranteed fit and galvanized finish for corrosion resistance



WESTERN CANADA

19402 54 Avenue
Surrey, BC V3S 7H9

T: 604-531-8408 / 1-877-531-8478
F: 604-531-8468 / 1-877-531-8468
info@pro-linefittings.com

EASTERN CANADA

740 Huronia Road, Unit #17
Barrie, ON L4N 6C6

T: 705-733-7720 / 1-855-733-7720
F: 705-733-7710 / 1-855-733-7710
sales@pro-linefittings.com

